



Industry Telephone Company

Customer User Guide

This document contains just about everything you need to know as a customer of Industry Telephone Company.



Table of Contents

Industry Telephone Company	3
About Us	3
Common Billing Terminology	4
Cramming	5
Customer Rights	5
Customer Proprietary Network Information (CPNI)	5
Fraudulent Collect Calls	6
Disclosure Under FCC Rule 64.1509 (b)	7
ETC Services Provided	7
General Information	8
How Can I Pay My Telephone Bill?	9
Lifeline Service	10
Servicio Lifeline	11
Postal Zip Codes	12
Prepaid Local Telephone Service	13
Slamming	14
Specialized Telecommunications Assistance Program	15
Texas Audio Newspaper Service	15
Universal Service Fund	15
Wire Requirements	16
7-1-1: Relay Texas	18
8-1-1: Call Before You Dig	19
800/ 900 Telephone Numbers	19
How To Check For Trouble On Your Telephone Line	20
Trouble With Your Telephone Service	21
Products & Services	22
Calling Features & Packages	23
Custom Calling Features	23
Advanced Calling Features	23
Packaged Services	23
Build Your Own Package With I-Choose*	23
Using Your Telephone Features	24
Industry I-Net	25
About Us	25
General Pricing	27
I-Direct DSL	27
I-Direct Enhanced Wireless	27

Modems & Modem Maintenance Policy	28
I-Net Long Distance	29
Flat Rate	29
Talk Cents	29
Easy Reach Nationwide Plan	29
800-Number	29
E-mail	30
Checking Your E-Mail From Anywhere	30
Industry I-Net Domain Mail Server Settings	30
Additional Webmail Helpful Links	30
Troubleshooting DSL	31
Have you power cycled (turned off and on) each of your devices?	32
2.4Ghz vs. 5Ghz WiFi: What's the difference and how to use it?	33
iVision	34
iVision Packages	35
iVision Installation	35
Additional Charges	35
Setting up Your Amazon Firestick	36
FireStick Generation 3 Remote Key Guide	38
Force Stop Your iVision App	39
Setting up Your TiVo Stream 4k	41
MORE INFORMATION ON YOUR TiVo STREAM 4K REMOTE	44
Remote Pairing	45
Remote Setup	46
Remote Troubleshooting	47
Traditional Amino Amigo Set Top Box with Maxi Remote	48
Amino Maxi Remote	48
Troubleshooting iVision TV Service	50
Common iVision Issues & Solutions	50
Completing a System Reboot	50
When a System Reboot Does Not Resolve a Problem	50
How do I record a program and how do I access them?	51
Record a Future Program	51
Record a Current Program	51
Manage Your Recordings	51
How to Setup TV Everywhere	52

Industry Telephone Company

About Us

Since 1955, Industry Telephone Company has been dedicated to providing dependable, quality service. We pride ourselves in our continuous effort to put the customer first. In keeping with that commitment to our customers, Industry Telephone Company has diligently kept on top of all available technology and maintained state-of-the-art equipment. We are the people who connect you to the world of telecommunications. We built the most reliable and technologically-advanced telecommunications network so that at home and at work you can have the best phone service possible.

Business Office Located At

17105 Fordtran Blvd.

P.O. Box 40

Industry, Texas 78944

979-357-4411

979-278-3600

1-888-212-8872

www.industrytelco.com



Common Billing Terminology

Access Recovery Charge (ARC) – A fee designed to recover a portion of the telephone company’s revenues to offset inter-carrier compensation revenue declines required by the Federal Communications Commission rules.

Federal Excise Tax – Federal tax assessed on non-usage sensitive basic local service that is billed separately from long distance service. Acceptable abbreviation: Fed Excise Tax.

Federal Subscriber Line Charge – A charge that the Federal Communications Commission (FCC) allows a Certified Telecommunications Utility (CTU) to impose on its customers to recover costs associated with interstate access to the local telecommunications networks. The FCC does not require a CTU company to impose this charge, and the CTU does not remit the charge to the federal government. The charge may be used by the CTU to pay for a part of the cost of lines, wires, poles, conduit, equipment and facilities that provide interstate access to the local telecommunications network. Acceptable abbreviation: Fed subscriber line chg.

Federal Universal Service Fee – A federal fee for a fund that supports affordable basic phone service to all Americans, including low-income customers, schools, libraries and rural health care providers. CTUs impose this fee to cover their required support for the fund. The fee is set by the FCC. Acceptable abbreviation: Fed universal svc fee.

Texas Universal Service – A state fee for a fund that supports affordable service to customers in high-cost rural areas, funds the Relay Texas service and related assistance for the hearing-disabled, and funds telecommunications services discounts for low-income customers (Lifeline). The fee is set by the Public Utility Commission.

9-1-1 Fee – A fee used to fund the 9-1-1 telephone network that allows callers to reach a public safety agency when they dial the digits “9-1-1”. The amount of the fee varies by region and is set by the Texas Commission on State Emergency Communications.

9-1-1 Equalization Fee – A fee used to provide financial support for regions where the 9-1-1 fee does not fully offset the cost of 9-1-1 service. The fee is imposed on each customer receiving intrastate long-distance service. The fee is set by the Texas Commission on State Emergency Communications.

Cramming

Placing charges on your phone bill for products or services without your authorization is known as “cramming” and is prohibited by law. Your telephone Company may be providing billing services for other companies, so other companies’ charges may appear on your telephone bill.

If you believe you were “crammed,” you should contact the telephone Company that bills you for your telephone service and request that it take corrective action. The Public Utility Commission of Texas requires the billing telephone Company to do the following within 45 days of when it learns of the unauthorized charge:

- Notify the service provider to cease charging you for the unauthorized product or service;
- remove any unauthorized charge from your bill;
- refund or credit all money to you that you have paid for an unauthorized charge; and
- on your request, provide you with all billing records related to any unauthorized charge within 15 business days after the charge is removed from your telephone bill.

If the Company fails to resolve your request, or if you would like to file a complaint, please write or call the Public Utility Commission of Texas, P. O. Box 13326, Austin, Texas 78711-3326, (512) 936-7120 or toll-free in Texas (888) 782-8477.

Hearing and speech-impaired individuals with text-telephones (TTY) may contact the commission at (512) 936-7136.

Your phone service cannot be disconnected for disputing or refusing to pay unauthorized charges. You may have additional rights under state and federal law. Please contact the Federal Communications Commission, the Attorney General of Texas or the Public Utility Commission of Texas if you would like further information about possible additional rights.

Customer Rights

Customer Proprietary Network Information (CPNI)

In the normal course of providing your telephone service, Industry Telephone Company maintains certain information about your account. This information, when matched to your name, address, and calling or originating billing telephone number, is known as your customer-specific “Customer Proprietary Network Information,” or CPNI for short. Examples of your CPNI include the type of line you have, technical characteristics (ex. touchtone or rotary service), class of service (business or residence), current telephone charges, long distance and local service billing records, directory assistance charges, usage data and calling patterns.

The Public Utility Commission of Texas (PUC) has adopted a rule which states that, upon your request, we may not use your customer-specific CPNI to market certain telephone services or features to you. In other words, if you request that your CPNI be considered “restricted”, Industry Telephone Company would be prohibited from using your CPNI to market to you certain telephone services for features that may be available to you from other sources. The only exception to the above prohibition is if you, the customer, initiate contact with us and inquire about these services or features.

It is important to note that restricting your customer-specific CPNI will not eliminate all of our marketing communications with you. We may continue to use your customer-specific CPNI to contact you regarding telephone services and features we offer that are not available to you from another source. We may also continue our marketing contacts that are not based on your customer-specific CPNI.

If you wish to have your customer-specific CPNI considered “restricted”, please call our Business Office at (979) 357-4411 or (979) 278-3600 or stop by our office at 17105 Fordtran Blvd (Hwy 159 West), Industry, Texas, and talk to one of our service representatives during our normal business hours. Simply tell us that you wish to restrict the use of your customer-specific CPNI. There will be no charge for restricting your customer information, and the restriction will remain in effect until you notify us otherwise.

Fraudulent Collect Calls

A collect call is a telephone call for which you will pay all charges for that telephone call. Customers should be aware that when they receive a collect call, they will be asked to accept or reject this type of call. Unless you are willing to pay those charges, do not accept the phone call.

Industry Telephone Company encourages customers to be certain of the caller's identification prior to accepting collect calls. If the caller's identification is not recognized, the customer should reject the call.

Before a collect call is connected you have the right to either accept or decline the charges. You should request the rate and charges of the collect call prior to accepting the charges. Once the collect call has been accepted, you will be billed for all charges connected to that phone call.

If you are billed for a collect call that exceeds a \$35 charge for a call less than five minutes in duration, you should contact Industry Telephone Company at:

17105 Fordtran Blvd
P. O. Box 40
Industry, TX 78944
(979) 357-4411 * (979) 278-3600
(888) 212-8872 toll-free
or the Public Utility Commission of Texas at:
PUC – Customer Protection
P. O. Box 13326
Austin, TX 78711-3326
(512) 936-7120
(800) 735-2988 TTY
(888) 782-8477 toll-free
(512) 936-7003 fax
customer@puc.state.tx.us

If you believe you have been billed for unauthorized collect call charges, the particular call or calls in question may be deducted from the bill upon notification to Industry Telephone Company, until the charges have been verified or adjusted. The balance of the bill is due and payable by the due date.

The Public Utility Commission of Texas has directed telecommunications providers to provide this notice to customers regarding your rights when accepting collect calls as there have been instances where collect calls have been placed for fraudulent reason. The company is required to monitor customer calls based on fraudulent collect calls. Therefore, if you believe to have been victimized by such practices, you are encouraged to report it.

Disclosure Under FCC Rule 64.1509 (b)

The Federal Communications Commission (FCC) also requires disclosures to telephone subscribers, which are as follows:

- Your local exchange and long distance service cannot be disconnected or interrupted as a result of your failure to pay charges for interstate pay-per-call service charges for interstate information services provided pursuant to a presubscription or comparable arrangement, or charges you have disputed for interstate tariffed collect information services.
- You can obtain blocking of access to services offered on the "900" service access code where it is technically feasible at no charge within 60 days after you subscribe to a new number and it becomes effective. Other requests for blocking and requests for unblocking will be subject to a reasonable onetime fee. Our tariffs include the terms and conditions that apply. You have a right not to be billed for pay-per-call services not offered in compliance with Federal laws and regulations established under Titles II or III of the Telephone Disclosure and Dispute Resolution Act.
- Your access to "900" services may be involuntarily blocked for failure to pay legitimate pay-per-call charges.

ETC Services Provided

Industry Telephone Company is committed to bringing its customers quality telecommunications services at affordable rates throughout its service territory. Basic local services are offered at the following monthly rates:

	CARMINE	INDUSTRY	NEW ULM
Single Party Residence*:	\$18.50	\$18.50	\$18.50
Emergency 911 Service Fee**:	\$0.50	\$0.50	\$0.50
Single Party Business*:	\$18.50	\$18.50	\$18.50
Tone Dialing Service:	\$0.00	\$0.00	\$0.00
*Rates do not include taxes, surcharges, or other fees that may be applicable, such as a subscriber line charge.			
** The Emergency 911 Service Fee for Austin County Customers is \$.90 for Residential Customers and \$3.23 for Business Customers.			

This service includes voice grade access to the public switched network, tone dialing, access to interexchange service, (long distance carriers), access to operator services and directory assistance, telecommunications relay service, and 911 emergency service. Each local exchange access line comes with a free primary directory listing and each subscriber annually receives the Company's local telephone directory. Also, unlimited local calling is provided within the customer's local calling area at no charge. To make sure that our customers continuously receive quality service, any service problems can be reported to Industry Telephone Company twenty-four hours a day, seven days a week.

Basic services are offered at the rates, terms and conditions specified in Industry Telephone Company's tariff on file with the Public Utility Commission of Texas. If you have questions regarding the Company's services or rates, please call 979-357-4411, 979-278-3600 or toll free 888-212-8872.

General Information

Allowance for Failure of Service

The Telephone Company does not guarantee uninterrupted working of its line or equipment. In case service is interrupted other than by the negligence or willful act of the subscriber, an adjustment will be made to the subscriber's account upon notification by the subscriber. Any adjustment shall apply only to the period the interruption continues beyond eight normal working hours. In any case, the Telephone Company assumes no additional liability.

Fire Alarms and Other Emergency Calls

The Telephone Company assumes no responsibility in accepting, handling or transmitting fire calls or other emergency calls of any nature.

Notification to Telephone Company When Moving

Subscribers need to notify the Telephone Company when their billing address changes. When moving out of the Telephone Company's exchanges, all leased equipment needs to be turned in to the business office.

Right of Access to Premises

At all reasonable times, the Telephone Company, through its authorized employees, shall have the right of access to the premises of the subscriber to install, inspect, repair or, upon termination, remove the Telephone Company's lines or equipment.

Error in Directories

The Telephone Company issues directories to assist it in furnishing prompt and convenient service, and it does not guarantee to its subscribers correct listings therein. Every precaution is taken to prevent errors and omissions, but they may occur. Neither the Telephone Company nor the Directory Company assumes any liability for damages to a subscriber by such errors or omissions in its directories.

Directory Distribution Center

Telephone directories may be ordered from anywhere in the world for a fee by calling 1-800-792-2665.

Rules and Regulations

Rules and regulations governing the furnishing of services by the Telephone Company are on file in the business office. Representatives are available to assist you in answering questions regarding your telephone service.

Notice

Cellular 9-1-1 Calls...When calling 9-1-1 on a cellular phone, be prepared to provide the following information: your name, cellular phone number, nature of the emergency and the location of the incident. Please note: Your call may be answered by a telephone company operator or a 9-1-1 dispatcher outside of your area.

Privacy Considerations... The 9-1-1 (nine-one-one) emergency telephone number has been developed to quickly summon emergency service in a crisis situation. Callers should realize that when reporting an emergency by dialing 9-1-1, their telephone number (including non-published numbers) and their address may be automatically displayed on viewing screen located at the 9-1-1 answering centers and that this call may also be recorded. This display of the calling number and address enables the emergency agency to quickly locate the caller if the call is disrupted by the crisis. Callers who do not wish to have their telephone number displayed on the viewing screen should report an emergency by dialing the seven-digit telephone number of the appropriate emergency agency.

How Can I Pay My Telephone Bill?

Industry Telephone Company offers several options that customers may use to pay their telephone bill.

- In person:
 - Industry Telephone Company
17105 Fordtran Blvd (Hwy 159 West)
Industry, TX 78944

(This location also has a 24 hour drop slot for payments)
- By mail:
 - Industry Telephone Company
PO Box 40
Industry, TX 78944
- Other locations:
 - Carmine State Bank
235 Centennial St
Carmine, TX 78932
(Payment must be there by the 10th of the month)

 - Industry State Bank – New Ulm Branch
1210 FM 109
New Ulm, TX 78950
(Payment must be there by the 10th of the month)
- ACH/Credit Card/Direct Debit:
 - Please contact Customer Service for details and set-up by dialing (979) 278-3600, (979) 357-4411 or toll free (888) 212-8872
 - Industry Telephone Company currently accepts MasterCard and Visa.
- Online:
 - There is a link on the Industry Telephone Company's website (www.industrytelco.com) that enables customers to set up a one-time payment, or recurring monthly payments, of their telephone bill. Please contact Customer Service for more information by calling the Business Office at (979) 278-3600, (979) 357-4411 or toll free (888) 212-8872.

Lifeline Service

Industry Telephone Company (“Industry”) is committed to bringing its customers quality telecommunications services at affordable rates throughout its service territory. Voice telephony service is provided at a rate of \$18.50 per month for both residential and business line customers. Broadband Internet access service is provided at rates which start at \$xx.xx per month for residential customers and \$xx.xx per month for business line customers. Industry would be pleased to provide you with specific rates for broadband for your area upon request.

Industry provides the supported services – voice telephony service and broadband access service – throughout its designated service area. These supported services include: voice grade access to the public switched network; minutes of use for local service provided at no additional charge; access to emergency services provided by local government or other public safety organizations, such as 911 and enhanced 911, to the extent the local government in Industry’s service area has implemented 911 or enhanced 911 systems.; and Broadband Internet access service which includes the capability to send data to and receive data from the Internet, but excludes dial-up service. To make sure that our customers continuously receive quality service, any service problems can be reported to Industry Telephone Company twenty-four hours a day, seven days a week.

Basic services are offered at the rates, terms and conditions specified in Industry Telephone Company’s tariff on file with the Public Utility Commission of Texas. If you have questions regarding the Company’s services or rates, please call 979-357-4411, 979-278-3600 or toll free 888-212-8872.

DISCOUNTS AVAILABLE FOR LOW INCOME CUSTOMERS

Industry Telephone Company offers reduced rates to eligible low-income residential consumers under a government assistance program called Lifeline. Lifeline provides monthly discounts to an eligible customer’s voice service or broadband service (home or wireless) but not both. Lifeline customers also have the option to apply the discount to a service bundle, such as home phone and home internet. Customers who are eligible for Lifeline on their voice service are also eligible for toll blocking at no charge. The current discount provided under the Company’s Lifeline service for Texas is up to \$12.75 per month for each month that the customer qualifies.

To be eligible for Lifeline a customer’s annual household income must be at or below 135% of the federal poverty guidelines for the federal discount, or at or below 150% of the federal poverty guidelines for the state discount, or a customer must receive benefits from or have a child in the household who receives benefits from at least one of the following programs: Medicaid, Supplemental Nutrition Assistance Program (SNAP), Supplemental Security Income (SSI), Federal Public Housing Assistance, Veterans or Survivors Pension Benefit, National School Lunch program (state only) LIHEAP (state only), or Health benefits coverage under the state Children’s Health Insurance Program (CHIP)(state only)

Lifeline service is limited to one discount per household. A household is everyone who lives in the home (including children and people who are not related to the customer) and shares income and household expenses (bills, food, etc.) A customer with Lifeline service may not transfer the Lifeline benefit to any other person. Lifeline is a nontransferable benefit.

Additional information may be obtained by contacting Industry Telephone Company’s business office at 979-357-4411, 979-278-3600 or toll free 888-212-8872 or by contacting the Low-Income Discount Administrator (LIDA) at 1-866-454-8387 (1-866-4-LITE-UP).

Servicio Lifeline

Industry Telephone Company ("Industry") se compromete a ofrecer a sus clientes servicios de telecomunicaciones de calidad a precios asequibles en todo su territorio de servicio. El servicio de telefonía por voz se proporciona a una tarifa de \$18.50 por mes para los clientes residenciales y de línea de negocio. El servicio de acceso a Internet de banda ancha se proporciona a tarifas que comienzan en \$ xx.xx por mes para clientes residenciales y \$ xx.xx por mes para clientes de líneas de negocio. Industria estaría encantado de proporcionarle tarifas específicas para la banda ancha de su área a petición.

Industry proporciona los servicios soportados - servicio de telefonía vocal y servicio de acceso de banda ancha - a través de su área de servicio designada. Estos servicios soportados incluyen: acceso de grado de voz a la red pública conmutada; Minutos de uso para el servicio local proporcionado sin costo adicional; Acceso a servicios de emergencia proporcionados por el gobierno local u otras organizaciones de seguridad pública, como el 911 y el 911 mejorado, en la medida en que el gobierno local en el área de servicio de la Industria haya implementado 911 o los sistemas 911 mejorados. Y servicio de acceso a Internet de banda ancha que incluye la capacidad de enviar datos y recibir datos de Internet, pero excluye el servicio de acceso telefónico. Para asegurarnos de que nuestros clientes reciben continuamente un servicio de calidad, cualquier problema de servicio puede ser reportado a Industry Telephone Company las veinticuatro horas del día, los siete días de la semana.

Los servicios básicos se ofrecen a las tarifas, términos y condiciones especificadas en la tarifa de la Compañía Telefónica de la Industria en el archivo con la Comisión de Servicios Públicos de Texas. Si tiene preguntas sobre los servicios o tarifas de la Compañía, llame al 979-357-4411, 979-278-3600 o al número gratuito 888-212-8872.

DESCUENTOS DISPONIBLES PARA CLIENTES DE BAJOS INGRESOS

Industry Telephone Company ofrece tarifas reducidas a consumidores residenciales elegibles de bajos ingresos bajo un programa de asistencia gubernamental llamado Lifeline. Lifeline ofrece descuentos mensuales a un servicio de voz o servicio de banda ancha (hogar o inalámbrico) de un cliente elegible, pero no ambos. Los clientes de Lifeline también tienen la opción de aplicar el descuento a un paquete de servicios, como el teléfono de casa y el internet en el hogar. Los clientes que son elegibles para Lifeline en su servicio de voz también son elegibles para el bloqueo de peaje sin costo alguno. El descuento actual proporcionado bajo el servicio Lifeline de la Compañía para Texas es de hasta \$12.75 por mes por cada mes que el cliente califique.

Para ser elegible para Lifeline, los ingresos anuales del hogar de un cliente deben ser iguales o inferiores al 135% de las pautas federales de pobreza para el descuento federal o al 150% de las pautas federales de pobreza para el descuento estatal o un cliente debe recibir beneficios de O tener un hijo en el hogar que reciba beneficios de al menos uno de los siguientes programas: Medicaid, Programa de Asistencia de Nutrición Suplementaria (SNAP), Ingreso Suplementario de Seguridad (SSI), Asistencia de Vivienda Pública Federal, Beneficios de Pensión para Veteranos o Sobrevivientes, (Sólo estado), o cobertura de beneficios de salud bajo el programa estatal de seguro médico para niños (CHIP) (sólo para el estado)

El servicio Lifeline se limita a un descuento por hogar. Un hogar es todos los que viven en el hogar (incluidos los niños y las personas que no están relacionados con el cliente) y comparte los ingresos y los gastos del hogar (facturas, alimentos, etc.) Un cliente con el servicio Lifeline no puede transferir el beneficio Lifeline a ningún otro persona. Lifeline es un beneficio intransferible.

Para obtener información adicional, comuníquese con la oficina de negocios de la Compañía Telefónica de la Industria al 979-357-4411, 979-278-3600 o al número gratuito 888-212-8872 o poniéndose en contacto con el Administrador de Descuentos de Bajos Ingresos (LIDA) al 1-866-454 -8387 (1-866-4-LITE-UP).

Postal Zip Codes

Bellville, Texas	77418
Bleiblerville, Texas	78931
Brenham, Texas	77833
Burton, Texas	77835
Carmine, Texas	78932
Cat Spring, Texas	78932
Columbus, Texas	78934
Fayetteville, Texas	78940
Giddings, Texas	78942
Industry, Texas	78944
La Grange, Texas	78945
Ledbetter, Texas	78946
New Ulm, Texas	78950
Round Top, Texas	78954
San Felipe, Texas	77473
Sealy, Texas	77474

Prepaid Local Telephone Service

Industry Telephone Company offers Prepaid Local Telephone Service (PLTS), which gives eligible customers an opportunity to manage outstanding telephone balances. PLTS is available as a one-time option for eligible customers. If you are a residential customer whose service has been suspended or disconnected for non-payment of charges, and you have never received PLTS from Industry Telephone Company, you can subscribe to PLTS.

PLTS customers receive flat rate basic local telephone service with touch tone, access to 911, access to Industry Telephone Company's repair and business services offices, a white pages directory listing or non-published service if requested and toll blocking. The charges for these services will be at Industry Telephone Company's tariffed rates. Applicable surcharges or fees must also be paid. Normal service connection and restoral fees may apply. PLTS customers must make an advance payment for up to two months of PLTS service and any applicable service charges. Subsequent payments are billed one month in advance, and must be paid by the due date.

PLTS does not include long distance calling, collect calling, access to directory assistance, or access to usage sensitive services such as call return, call trace and auto redial. Other services provided by Industry Telephone Company are not available to PLTS customers.

PLTS service will be disconnected immediately without notice for violation of the PLT requirements and the customer will not be eligible for PLTS service again with Industry Telephone Company.

A PLTS customer can return to basic local telephone service when the customer has a zero balance on the PLTS account and has paid all outstanding debt owed to Industry Telephone Company, including toll charges.

Eligible customers may subscribe to PLTS, or obtain more information, by contacting the Industry Telephone Company Business Office at (979) 357-4411 or 278-3600 during normal business hours.

Slamming

The Public Utility Commission of Texas has directed each telecommunications utility to provide this notice to customers regarding your rights when selecting a telecommunications utility. Telecommunications utilities (telephone companies) are prohibited by law from switching you from one telephone service provider to another without your authorization, a practice commonly known as “slamming”

If you are slammed, you should contact your new provider – the telephone company that switched you without authorization – and request that it return you to your original telephone service provider.

Texas law requires a local or long distance telephone service provider (telephone company) that has slammed you to do the following:

- Pay all the usual and customary charges associated with returning you to your original telephone Company within five business days of your request to be returned to your original telephone Company.
- Provide all billing records to your original telephone Company within 10 business days of your request to be returned to your original telephone Company.
- Pay the original telephone Company the amount you would have paid to your original telephone Company if you had not been slammed.
- Refund to you, within 30 business days, any amount you paid for charges during the first 30 days after the slam, and any amount more than what you would have paid for identical services by your original telephone Company after the first 30 days following the slam.

Please note that once your original telephone Company has been paid by the slamming Company, your original telephone Company is required by law to provide you with all the benefits (e.g., frequent flyer miles) you would have normally received for your telephone use during the period in which you were slammed.

If you have been slammed, you can change your service immediately back to your original provider by calling your local telephone company. You should also report the slam by writing or calling the Public Utility Commission of Texas, P. O. Box 13326, Austin, Texas 78711-3326, (512) 936-7120 or toll-free (888) 782-8477, fax: (512) 936-7003, e-mail address: customer@puc.state.tx.us. Hearing and speech-impaired individuals with text telephones (TTY) may contact the commission at (512) 936-7136.

Complaints relating to slamming, the unauthorized change in a customer’s telephone Company, are investigated by the Public Utility Commission of Texas. If a telephone Company slams you and fails to resolve your request to be returned to your original local or long distance telecommunications service provider as required by law, or if you would like a complaint history for a particular telephone Company, please write or call the Public Utility Commission of Texas, P. O. Box 13326, Austin, Texas 78711-3326, (512) 936-7120 or in Texas toll-free (888) 782-8477. Hearing and speech-impaired individuals with text telephones (TTY) may contact the commission at (512) 936-7136.

You can prevent slamming by requesting a preferred telephone company freeze from Industry Telephone Company. With a freeze in place, you must give formal consent to “lift” the freeze before your phone service can be changed. A freeze may apply to local toll service, long distance service, or both. The Public Utility Commission of Texas can give you more information about freezes and your rights as a customer. For additional information, contact the Industry Telephone Company Business Office at (979) 357-4411 or 278-3600 during normal business hours.

Specialized Telecommunications Assistance Program

The Specialized Telecommunications Assistance Program (STAP) provides financial assistance to help Texas residents with disabilities purchase basic specialized equipment or services needed to access the telephone network. For more information, contact the Texas Commission for the Deaf and Hard of Hearing at (512) 407-3250 (Voice) or (512) 407-3251 (TTY) or www.tcdhh.state.tx.us. This program is open to all individuals who are residents of Texas and have a disability.

Texas Audio Newspaper Service

Texas residents who are blind or visually impaired may qualify for a new service that gives them access to national and local newspapers via synthetic speech. Beginning in September of 2006, customers with vision impairment may apply with the National Federation of the Blind to register for this free service by telephone called Audio Newspaper. The service is funded by Texas telephone customers through the Texas Universal Service Fund.

Residents are eligible if they participate in a state or private vocational program for the blind, are enrolled in a public special education program or state school for the blind, are a client of the Texas Division of Blind Services, are registered with the Texas State Library and Archives Talking Book Program, or possess a physician's statement certifying legal blindness or visual impairment. Touch-tone telephone service is required in order to reach Audio Newspaper.

For more information regarding the free service or to register for the free service, contact the National Federation of the Blind at:

Toll-free Telephone Number: 1 (866) 636-3289

Fax Number: 1 (512) 420-8160

Mailing Address:

National Federation of the Blind of Texas

314 E. Highland Mall Blvd.

Austin, TX 78752

Website: <http://www.nfb.org>

Universal Service Fund

You may notice a charge called "Texas Universal Service" that pays for the Texas Universal Service Fund. This fund was created by the State of Texas to help pay for low income customers and customers in high cost rural areas and to serve customers with disabilities. This charge is approximately 3.30 percent of your bill and is being offset by reductions in in-state long distance charges. If you have any questions about this charge or how it is calculated, please call Industry Telephone Company.

Wire Requirements

Construction Requirements

- An engineer from Industry Telephone Company (ITC) will meet with customer to plan construction and locate existing underground facilities.
- ITC will repair any facilities, at no charge, damaged during construction if such facilities were made known at the time the engineer met with the customer.
- ITC will repair facilities damaged by construction not located or brought to our attention by customer prior to construction at customer cost. ITC will not be responsible for damages to facilities that are damaged due to customer not telling ITC of its existence. However, if we know we have damaged a line (sewer, water, electric, etc.), we will notify the customer and make all arrangements possible to shut off the water or power until the customer can make arrangements to repair.
- It is essential that customer locate all underground facilities prior to construction. If there is a doubt of its location, ITC will assist customer in trying to locate lines.
- Customer will need to show ITC cutoffs to water and power in case of accidental damage to lines.
- ITC will be responsible for any damages done to property due to negligence on our part.
- Clean-up will be done to the best of our ability to restore ground back to original condition. However, if ground conditions are “too wet” and customer still wants us to do construction, we will not be responsible to damages done (ruts, sinkholes, etc.) in cases where ground conditions do not allow proper clean up.
- Customer needs to make arrangements for construction of telephone lines to go smoothly. Such as wiring to side where minimum lines will be crossed.
- If driveways or sidewalks will be installed, notify ITC prior to construction so phone lines can be installed before construction begins. This saves boring and digging large holes in the construction of the line. This also speeds up the construction of your line.
- Customer needs to notify ITC of all vegetation that customer does not want damaged during construction at time of engineering (plants, trees, grass, etc.). Occasionally, limbs will be trimmed to allow machinery in and out of construction site. This will be done as neatly as possible.

If there is a problem during or after construction, please contact Industry Telephone Company at 979-357-4411 or 1-800-212-8872 and it will be resolved ASAP.

Mobile Home Wiring

In the past, Industry Telephone Company (ITC) has encountered wiring done by the manufacturer that is not consistent with our wiring procedures. When wired, they have installed short pieces of wire directly below each jack, but do not leave enough wire to connect all the jacks together, or they have the wires connected, but do not leave enough wire to go to the outside of the home. In some cases, no wire can be found at all leaving the home. Please make sure you make arrangements with the mobile home manufacturer to wire properly. ITC will charge wiring rates for any wiring we do to make jacks work at customer request.

If you have any wiring questions, call Industry Telephone Company at 979-357-4411 or 1-800-212-8872 and it will be resolved ASAP.

Wiring Requirements by Customer

- Wiring should be done at accessible location so that Industry Telephone Company (ITC) facilities can easily connect to.
- Wiring at the protector should be a minimum height of 3' to maximum of 5'
- Excess wiring should be at least 5' long in order to make proper connections
- A #10 ground wire should be installed to the power ground (ground rod) where power enters site. ITC will ground if wiring is close to power ground and accessible. If distance is long and not easily accessible, ITC may have to attach ground wire to outside of house. Due to this, it is easier to ground when construction of home is underway and it can be run inside walls to power ground. If customer wires home away from power, we suggest they run ground wire also.
- ITC will hookup customer wiring at time of installation of service. If any problems arise due to customer wiring of facilities, ITC will repair at ITC wiring rates (jacks wired wrong, not connected, 2nd lines not located in right areas, etc.).
- When ITC goes to locations to install 2nd lines, although wiring is there, sometimes ITC still has to rearrange in jacks to get second line to proper jack. In this case, ITC will charge wiring rates.
- If any wiring (wiring & jacks) is done by the customer or outside contractor, then a wire maintenance agreement cannot be used. Any wiring done by someone other than ITC personnel will void any existing wire maintenance agreement.
- It is suggested that in the construction of new homes; that if the home is wired by the customer, the customer wire all sites possible (even if there are no plans for a phone in that room) while construction is underway. It is easier to wire while the walls are down.
- ITC suggests that you wire no more than 3 jacks in each run. (Better to have no more than 2), thus preventing the possibility of a bad wire not allowing all jacks in home not to work.
- ITC suggests customers use a 4 pair wire or greater to allow for the addition of more lines to be added to the home.
- Remember, anything we do past our connection point (NID) is subject to a wiring charge.
- In the past, customers have wired jacks incorrectly causing trouble when ITC hooks up at the NID correctly. Use the wiring diagram below to make jack connections.

2 Pair Wire		Jack
Red	-	Red
Green	-	Green
Yellow	-	Yellow
Black	-	Black

4 Pair Wire		Jack
White (Blue Stripe)	-	Green
Blue	-	Red
White (Orange Stripe)	-	Yellow
Orange	-	Black
White (Green Stripe)	-	Spare
Green	-	Spare
White (Brown Stripe)	-	Spare
Brown	-	Spare

Wiring Questions? Call Industry Telephone Company at 979-357-4411 or 1-800-212-8872 and it will be resolved ASAP.

7-1-1: Relay Texas

Most Texans are now able to reach Relay Texas by dialing 7-1-1 instead of dialing the 10-digit 800 numbers. The Federal Communication Commission (FCC) has set aside 7-1-1 specifically for states to use for their relay services. Use of 7-1-1 supplements access to the Texas Relay System, and does NOT replace or change the existing 800 access numbers for voice or TTY users.

By dialing 7-1-1 both hearing and deaf, hard-of-hearing, deaf-blind, or speech-impaired users can initiate a Relay Texas call. Specially trained operators of the Relay Texas System answer the calls to the Relay Center and relay the conversation between the two parties by using equipment that enables them to hear the voice user and read the signals from the TTY (text telephone) user. All calls are handled with strict confidentiality.

NOTE: 7-1-1 is not to be confused with 9-1-1. Some have asked if 7-1-1 is an "emergency number of TTY users." IT IS NOT! It is simply a short cut to dialing the Relay service. In an emergency, relay users should always call 9-1-1. In an emergency, every second counts and by calling Relay Texas First, time is lost attempting to determine the caller's local emergency numbers.

Relay Texas service is available 24 hours a day, 365 days a year, with no restrictions on the number of calls placed or the length of the calls. Relay Texas users can communicate to anywhere in the United States. There is no charge for Relay calls made within your local calling scope.

To learn more about [Relay Texas](#), contact the Relay Texas office at 1-800-676-3777 or the Public Utility Commission of Texas at (512)936-7147 (TTY).

1-800-RELAY TX

1-800-735-2989 (TTY)

1-800-RELAY VV

1-800-735-2988 (VOICE)

1-800-RELAY XI

1-800-735-2991 (ASCII)

8-1-1: Call Before You Dig

8-1-1 is an abbreviated dialing arrangement that enables end users the ability to reach the state One Call Notification systems providers. The 8-1-1 service is used to provide advance notice of excavation activities to underground facility operators. All too often, private home owners and construction crews unintentionally dig up land where various lines and telephone cables are located. This can result in costly damage and/or destruction. By working together, we can avoid unnecessary disruption of service within our community.

- The One Call Notification Centers in Texas are:
 - Lone Star Notification Center (www.lsnconecall.com)
 - Underground Utility Locate Requests: (800) 669-8344
 - Administration Number: (713) 432-0365
 - DIG-TESS (www.digtess.org)
 - Underground Utility Locate Requests: (800) 344-8377
 - Administration Number: (972) 231-5497
- Visit <http://www.texas811.org/> Before You Dig
 - Go online with 24/7 access to create and manage all ticket types including Update & Remarks, Dig Ups and even Emergencies. This service requires a short 45 minute online training session.
- Text Texas811 Before You Dig
- Text TEXAS811 to 936-CALLPLS (936-225-5757). This text feature will place the caller in the queue for the next available agent, and they will call you back.
- You may also contact Industry Telephone Company to request a cable locate.
 - Carmine: 278-3600 or Toll Free 1 + (888) 212-8872
 - Industry/New Ulm: 357-4411 or Toll Free 1 + (888) 212-8872

Cable locates are free....Cut cables are not.

800/ 900 Telephone Numbers

When an 800 or 900 number is dialed from your telephone, your telephone number may be transmitted to the company you have called and may be available to that company's service representative before your call is answered. Please be advised that 900 numbers and some 800 numbers have per minute charges associated with them.

How To Check For Trouble On Your Telephone Line

For your convenience, Industry Telephone Company is installing a Network Interface Device (NID) at each residence. The NID is usually located where the telephone service enters the home on the outside of the house. This NID will help you determine if your telephone or inside wiring is the cause of the trouble or if it is necessary to call Industry Telephone Company's Trouble line @ 979-357-2511 or 979-278-3600.

To test the phone line, open the cover of the NID. Remove the plug from the test jack and plug a working telephone into the test jack. If there is a dial tone and you are able to make a telephone call, the trouble is in either the inside wiring or your telephone. If there is not a dial tone, call Industry Telephone Company's Trouble line @ 979-357-2511 or 979-278-3600.



Trouble With Your Telephone Service

Repair Service Policy

Industry Telephone Company is responsible for the maintenance and repair of the telephone line up to your home or business. If you have a problem with your telephone service, it is important for you to determine if the problem is related to your customer-owned equipment and/or inside wire before making the call to Industry Telephone Company. If our dispatched repair technician determines that the problem is with your equipment and not the telephone company's equipment, you may be billed for labor plus and associated materials. The labor charges are based on the current hourly rate and are subject to change without notice. Service order charges and any other telephone company charges may also apply.

To Report Trouble

To report trouble with your telephone service, please call the Industry Telephone Company's Trouble Line at 357-2511, 278-3600 or toll-free 1-888-212-8872. If the call is made after regular business hours, the line will be sent to voice mail. Please leave your name, telephone number, a short description of the trouble you are having and a telephone number where you can be reached. A repairman will be dispatched as soon as possible. If you are experiencing trouble placing long distance calls, please call your long distance provider.

To Check for Trouble

Industry Telephone Company is installing a Network Interface Device (NID) at each residence. The NID is usually located where the telephone service enters the home on the outside of the house. This NID will help you determine if your customer-owned equipment and/or inside wire is the cause of the trouble.

To test the phone line, open the cover of the NID. Remove the plug from the test jack and plug a working telephone (do not use a cordless telephone) into the test jack. If there is a dial tone and you are able to make a telephone call, the trouble is in either the inside wiring or your customer-owned equipment. If there is not a dial tone, please call the Industry Telephone Company's Trouble Line at 357-2511, 278-3600 or toll-free 1-888-212-8872.

Inside Wire Maintenance

For protection against costly repair charges to your inside wire, Industry Telephone Company offers a maintenance service on simple inside wiring for a monthly charge of \$2.00 for each access line at your home or business. When adding this service to an existing account, a service order charge will be assessed. For more information, please call an Industry Telephone Company Customer Service Representative.

Leased Telephone Equipment

Telephone equipment leased from Industry Telephone Company will be maintained by the Company at no charge to the customer, unless it is determined that the cause of the problem was by abuse or misuse. If you are not sure about whether you will be charged for reporting trouble, please ask one of our Customer Service Representatives when placing the trouble report.

Products & Services

Custom Calling Features

Internet

I-Direct DSL offers you blazing speeds and continuous access to the Internet. DSL service is available only to customers on the Industry Telephone Company Exchanges. Price does not include installation fee.

Long Distance

Voicemail

Direct Connect Service

Provides that one designated telephone number will ring whenever the subscribing customer's telephone is off the hook for a minimum of seconds.

Direct Pay

Provides for the automatic drafting of money from your account for the payment of your telephone bill.

Extra Listing

Placing a separate additional listing in the telephone directory

Inside Wire Maintenance Agreement

Protect your Inside Wire and Jacks from costly repair.

Lease or Buy Telephone Equipment

We have a wide variety of telephones and telephone equipment for sale or lease.

Non-Published Number

Your telephone number is neither printed in the telephone directory nor available through Directory Assistance.

Toll Restriction

Denies all outgoing telephone calls starting with the digit "1".

Touch-Tone Service

With touch-tone service, you have the ability to dial faster and can access computer generated services.

Unlisted Number

Your telephone number is not printed in the telephone directory, but is available through Directory Assistance. For more information on the services listed, or inquiries on any new services available, please call one of our service representatives at 979-357-4411, 979-278-3600 or toll free 1-888-212-8872.

Calling Features & Packages

Custom Calling Features

Tone Dial	N/C
Call Waiting/Call Waiting Disable	\$1.25*
Call Forwarding	\$1.00*
Three Way Calling	\$1.25
8-Number Speed Dialing	\$1.00
30-Number Speed Dialing	\$1.50
Direct Connect Service	\$1.50
Calling Card	\$1.00

Advanced Calling Features

Anonymous Call Rejection	\$1.00 (.50 w/Caller ID)
Automatic Callback	\$2.00*
Automatic Redial	\$2.00*
Block 900/976 Number Calls	N/C for 1st Block, \$5.00 thereafter
Caller ID- Call Name & Number Delivery	\$6.50*
Caller ID Call Number Delivery Only	\$4.00
Caller ID w/ Call Waiting	\$1.50
Collect Call Restriction	N/C
Distinctive Alert Call Ring/Call Waiting	\$3.00*
Per-Call Blocking	N/C*
Remote Access to Call Forwarding	\$3.00
Selective Call Acceptance	\$2.00*
Selective Call Forwarding	\$2.00*
Selective Call Rejection	\$2.00*
Third Number Restriction	N/C
Toll Restriction Service	\$1.00
Toll Restriction with PIN Override	\$3.00

Packaged Services

Call Waiting, Call Waiting Disable, Call Forwarding, & Three Way Calling	\$3.00
Call Waiting, Call Waiting Disable, Call Forwarding, Three Way Calling & 8 Number Speed Dialing	\$3.75

Build Your Own Package With I-Choose*

I-Choose 3*	\$6.75
I-Choose 5*	\$10.50
I-Choose All*	\$13.25

Using Your Telephone Features

Feature	Activation	Deactivation
Call Hold	*0	
Short Speed Call	*2 - *9	
Long or Group Speed Call	*20-*49	
Call Forwarding Internet Down	*52	*53
Ring Again	*66	*86
Fixed Call Forwarding	*68	*88
Cancel Call Waiting	*70	
Call Forwarding	*72	*73
Short Speed Call list- Update	*74	
Long or Group Speed Call list- Update	*75	
Dial Call Waiting	*76	
Directed Call Pick-up	*78	
User Programmable Call Forwarding Busy	*90	*91
User Programmable Call Forwarding No Answer	*92	*93
Directed Call Park	*108	
Call Pick-up	*113	
Call Park	*117	
Retrieve Parked Call	*118	
MADN Hold (For Model 2500 Telephone Sets)	*114	*115
Customer Originated Trace	*57	
Selective Call Rejection	*60	
Selective Distinctive Ringing	*61	
Selective Call Forwarding	*63	
Selective Call Acceptance	*64	
Caller Identity Delivery (usage-sensitive)	*65	*85
Automatic Callback	*66	*86
Block Caller Identity Delivery	*67	
Allow Caller Identity Delivery	*82	
Anonymous Call Rejection	*77	*87
Automatic Recall		*89

Industry I-Net

About Us

Since April of 1996, Industry I-Net, Inc. has provided a wide variety of Internet services for Austin County and outlying areas. Industry I-Net has always placed its emphasis on the customer and their needs whether residential or business. Every business needs and pursues a customer base, but a happy and satisfied customer base is our main priority.

The office staff includes business services for billing and accounting and technical support. Additional staff members are responsible for network engineering and maintenance, Unix and server operation, plus second-tier customer technical support. The company's network and server equipment is located within the secured space of Industry Telephone Company.

Industry I-Net, Inc. is a solid and stable Internet Service Provider providing a variety of Internet services. These services include I-Direct DSL, Enhanced Wireless, Long Distance, Web Hosting and Co-location Services. Industry I-Net has built a reputation for providing dependable network service. This is due to the selection and installation of top-quality equipment that minimizes down-time, as well as a professional staff for both business and technical services.

Business Office Located At

17105 Fordtran Blvd.

P.O. Box 372

Industry, Texas 78944

979-357-4411

1-888-212-8872

www.industryinet.com



Internet Support

For troubleshooting and technical support for internet & email, please use the contacts below:

24/7 Help Desk: 888-423-5733 OR 979-357-4638

Business Office: 800-212-8872 OR 979-357-4411 (*Available M-F from 8 a.m. to 5 p.m.*)

General Pricing

I-Direct DSL

I-Direct DSL offers you blazing speeds and continuous access to the Internet. Pick up your phone, make a call, talk and surf the net at the same time. No time wasted connecting- your connection is always on! DSL service is available only to customers on the Industry Telephone Company Exchanges.

Plans	Speeds Up To	Availability	Pricing
Basic DSL	3.0 Mbps Download	Residential	\$39.95
Basic DSL +Talk Cents	3.0 Mbps Download	Residential	\$34.95
Premium DSL	6.0 Mbps Download	Business + Residential	\$54.95
Premium DSL+Talk Cents	6.0 Mbps Download	Business + Residential	\$49.95
Turbo DSL*	10 Mbps Download	Residential	\$69.95
Turbo DSL+Talk Cents*	10Mbps Download	Residential	\$64.95
Enhanced DSL*	15 Mbps Download	Business + Residential	\$79.95
Enhanced DSL+Talk Cents*	15 Mbps Download	Business + Residential	\$74.95
Extreme DSL*	20 Mbps Download	Business + Residential	\$99.95
Extreme DSL+Talk Cents*	20 Mbps Download	Business + Residential	\$94.95
DSL Only (No Telephone)	20 Mbps Download	Residential	\$99.95
Add-A-Meg (Available w/ Extreme)	1 Mbps Download	Residential	\$1.95

***Turbo, Enhanced and Extreme services may not be available at this time in some locations.**

Standard Modem One-Time Installation for DSL	\$99.00 + tax
Wireless Modem One-Time Installation for DSL	\$144.00 + tax

I-Direct Enhanced Wireless

Turn Your Home into Your Own Private Hotspot Starting at \$9.95 a Month (Site Survey Required)

Enhanced wireless is a service we offer that allows you to expand your DSL connection wirelessly throughout your home and surrounding outside areas. Structural and environmental elements will determine the range of coverage. We basically take the dependable wire line DSL connection to your home and turn it into your own personal Wi-Fi Hotspot. We currently offer DSL modems with wireless capabilities which are sufficient in most cases in smaller homes, but our "Enhanced Wireless" product takes your wireless service to a whole new level by customizing a deployment of one or several of our high powered wireless access points.

Benefits of Enhanced Wireless

- Wider range of coverage and a stronger wireless signal for optimum reception and bandwidth.
- Increased range of mobility for wireless devices such as IPADS, SmartTV's, Iphones, Laptops, Androids or any other devices that require Internet access.
- By connecting to your own local wireless hot spot when you are at home and not out and about, you decrease the amount of data usage associated with your wireless phone service through AT&T, Verizon, Sprint and other wireless plans you pay for each month. This provides a possible cost savings on bandwidth usage associated with those services.
- Access Point Management, Changes and Firmware upgrades for your Wireless Access Point are maintained remotely from our offices here in Industry.
- 24/7 Device Monitoring ensuring Access Point connection stability.

Modems & Modem Maintenance Policy

Upon activation and installation of your DSL service you will be provided a DSL modem. This modem conforms to the specifications and configuration requirements of the Industry I-Net broadband network infrastructure. Industry I-Net, Inc. has made available 2 options in which a customer can receive a configured DSL Modem from Industry I-Net should your modem need to be replaced.

Option #1: Pay Upon Replacement

Under the Pay Upon Replacement option, should the modem become defective or fails to perform, I agree to pay for the purchase price of the modem and all configuration, installation, labor and transport costs associated with replacing the modem. Due to concerns with provisioning and compatibility issues, DSL modems may only be purchased through Industry I-Net. Replacement modems can be purchased at the rates listed below.

- Standard DSL Modem - \$134.95
: (Modem \$69.95 + Configuration \$65.00 + tax)
- 4-Port DSL Modem - \$164.95
: (Modem \$99.95 + Configuration \$65.00 + tax)
- Wireless DSL Modem - \$164.95
: (Modem \$99.95 + Configuration \$65.00 + tax)

Option #2: Modem Maintenance Plan

Under the Modem Maintenance Program option, Industry I-Net, Inc. will repair or replace a non-working modem free of charge. Also, all associated labor and configuration charges associated with replacing the modem will be waived, unless it is determined that the trouble is attributable directly to customer mishandling or abuse of the modem. Customers can elect the Modem Maintenance program at the monthly rates listed below:

- Standard DSL Modem \$3.00 per month
- 4-Port DSL Modem \$5.00 per month
- Wireless DSL Modem \$5.00 per month

I-Net Long Distance

Flat Rate

Residential Flat Rate	No Monthly Charge	12¢ minute
Business Flat Rate	No Monthly Charge	15¢ minute

Talk Cents

Residential Talk Cents	\$4.95 per month on first line & \$2.95 each additional line	7¢ minute
Business Talk Cents	\$9.95 per month on first line & \$4.95 each additional line	7¢ minute

Easy Reach Nationwide Plan

- Call **anywhere** in the continental US anytime for one flat rate of \$35.00.
- Toll detail will be presented on your bill for your convenience.
- No Installation Fees.
- Easy Reach is subject to [terms and conditions](#) of plan.

800-Number

Industry I-Net now has 800-number service.

Have your own 800 number for **\$9.95** a month and **6.9 cents** a minute.

E-mail

Checking Your E-Mail From Anywhere

Check your mail from any location or computer by going to [Industry I-Net Webmail](#) . Enter your full e-mail address and password.

Industry I-Net Domain Mail Server Settings

Access your Industry I-Net e-mail on any mail client, any device, anytime with the given settings:

Display Name:	Your full name as you want it to appear in emails
Email Address:	Your email address, e.g. username@industryinet.com
Mail Type:	POP
Incoming Mail Server:	pop.industryinet.com; Port: 110
Outgoing Mail Server:	smtp.industryinet.com; Outgoing mail server must be configured to authenticate. Select option to use the same username and password as the incoming; Port: 587
User Name:	username@industryinet.com
Password:	Industry I-Net supplied e-mail password

Additional Webmail Helpful Links

Client & Device Mail Setup

<http://guides.myonlinehelp.net/docs/industryinet.com/updatesettings>

Webmail Power User Guide

<http://guides.myonlinehelp.net/docs/industryinet.com/zwebmail>

Email basics: Reading Email, Writing Email, etc.

http://guides.myonlinehelp.net/docs/industryinet.com/zwebmail_email_basics

FAQ

http://guides.myonlinehelp.net/docs/industryinet.com/zimbra_faq

Contacts

<http://guides.myonlinehelp.net/docs/industryinet.com/zcontacts>

New User

<http://guides.myonlinehelp.net/docs/industryinet.com/newuser>

CalDAV and CardDAV

http://guides.myonlinehelp.net/docs/industryinet.com/zimbra_cardcal

Calendars

<http://guides.myonlinehelp.net/docs/industryinet.com/zcalendars>

Organizing

<http://guides.myonlinehelp.net/docs/industryinet.com/zorganize>

Rules and Filters

<http://guides.myonlinehelp.net/docs/industryinet.com/zfilters>

Troubleshooting DSL

What can I do if my High-Speed Internet service stops working?

1. Is your telephone line filtered and working properly?

- High-Speed Internet travels over the same lines as your telephone service. If none of your phones are working, there may be a problem with your phone line. Or, if you are experiencing static or noise, you may need to install or check the filters on the telephone jacks that have non-DSL devices attached.
- Check to make sure that you can make and receive calls from the jack into which your DSL modem is plugged.
- Check to make sure that there are DSL filters on ALL of the telephone jacks that have non-DSL devices attached (e.g.: cordless phones, wall phones, fax machines, satellite receivers, etc.).

**If your phones are not working, or if installing the filters does not remove the noise or static, please contact us.

2. Are all of your cables connected properly?

- Check all of your computer cable connections to make sure they are in working order and are properly connected.
- Unplug and re-insert each end of the cables that go to and from your modem, router (if you have one), and computer.

The diagram below will serve as a guide. Please note that your configuration may be slightly different than the diagram below.

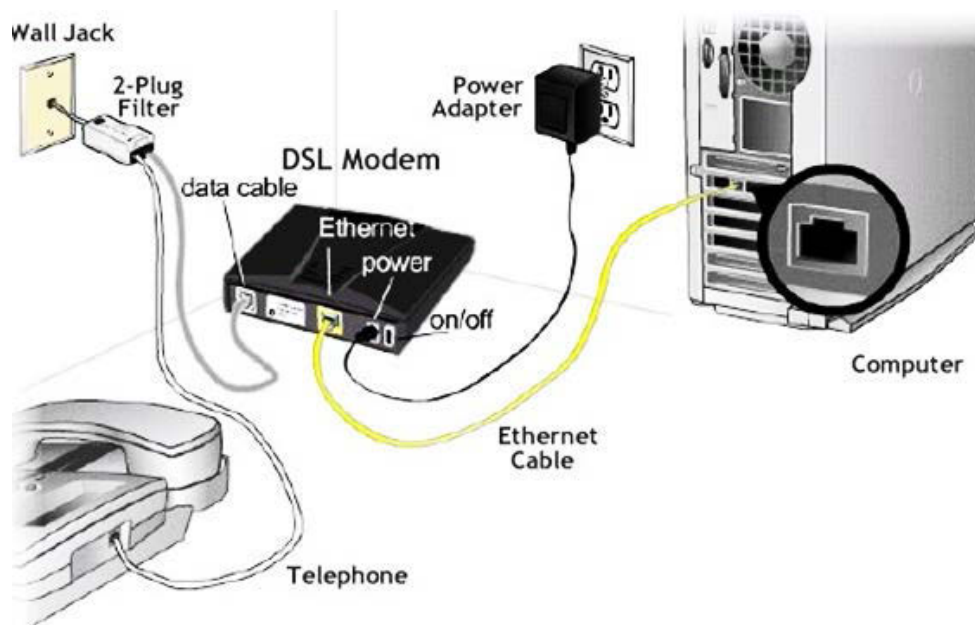

3. Is your modem working properly?

- a. Verify that there is power to your modem, and make sure the light switches, breakers, power strip, etc., that control the outlet, are working.
- b. When your modem is connected properly to the computer and DSL line, it will illuminate several lights. These lights tell you the status of your:
 - i. Power
 - ii. DSL signal on the phone line
 - iii. Ethernet connection to your computer (LAN)

(Note: If you unplugged your modem at step 2, your modem can take up to two minutes to fully power on and illuminate properly.)

If your modem does not have a solid green Power light, a solid green Status light, and a solid or flashing green LAN light, please contact us.

4. Have you made any changes?

- a. Changes to any of the following may impact your connection to the Internet:
 - i. New or additional phone installation or wiring.
 - ii. Changes to electrical wiring within your home.
 - iii. Adding a new Surge Protector or Uninterruptible Power Supply (UPS).
 - iv. Adding a new desktop or laptop PC.
 - v. Adding or modifying software on your desktop or laptop PC.
 - vi. Adding an internet router or wireless access point.

If you have made one or more of these changes, return the system to your prior configuration and check the connection again.

Have you power cycled (turned off and on) each of your devices?

- b. Follow the steps below, in this exact order, to cycle your equipment:
 - i. Turn off and unplug your computer from the electrical outlet.
 - ii. Turn off and unplug your modem from the electrical outlet.
 - iii. Turn off and unplug your router (if you have one) from the electrical outlet.
 - iv. Wait sixty seconds for the modem and line equipment to reset.
 - v. Turn on your modem. Wait two minutes until the Power and Status lights are solid green.
 - vi. Turn on your Internet router if you have one.
 - vii. Turn on your PC.

If your Internet service is still not working or if you have any questions, please call our office at 979-357-4411 OR you can contact our *24/7 Help Desk Support at 1-888-423-5733*

2.4Ghz vs. 5Ghz WiFi: What's the difference and how to use it?

The terms "2.4 GHz" and "5 GHz" refer to different frequency bands used for wireless communication, particularly in Wi-Fi networks. Here are the key differences between the two:

1. **Frequency:** The numbers 2.4 GHz and 5 GHz represent the frequency at which the signals are transmitted. 2.4 GHz operates on a lower frequency, while 5 GHz operates on a higher frequency.
2. **Speed:** In general, 5 GHz offers faster data transfer speeds compared to 2.4 GHz. This is because the higher frequency of 5 GHz allows for greater bandwidth and less interference, resulting in faster and more reliable connections. If you have a high-speed internet connection, using the 5 GHz band can maximize your network's performance.
3. **Range:** One advantage of 2.4 GHz is its ability to cover a larger range compared to 5 GHz. The lower frequency signals used in the 2.4 GHz band can penetrate walls and other obstacles more effectively, making it suitable for larger spaces or areas with many obstructions. 5 GHz signals, on the other hand, have a shorter range but can provide better performance within a smaller distance.
4. **Interference:** Since 2.4 GHz is a more commonly used frequency band, it is more susceptible to interference from other devices that operate on the same frequency, such as cordless phones, microwaves, and Bluetooth devices. This interference can cause signal degradation and slower speeds. 5 GHz, being less crowded, experiences less interference and can provide a more stable connection in environments with numerous wireless devices.
5. **Device compatibility:** Most devices, including older ones, support the 2.4 GHz band. However, newer devices, such as smartphones, tablets, and laptops, are increasingly equipped with support for both 2.4 GHz and 5 GHz. Dual-band routers are also widely available, allowing you to connect devices to either frequency.

In summary, the 2.4 GHz band offers better range and compatibility with older devices, while the 5 GHz band provides faster speeds and less interference. The choice between the two depends on your specific needs, the environment you are in, and the devices you are using.

[back](#)

iVision

Over the years, Industry I-Net's customer base has played huge part in the development of our products and service. The same applies with the introduction of newest version of iVision. We ask our customers to join us in the development of this service and welcome feedback for future improvements.

Our new Streaming Video Platform is very diverse, offering you options that fit your needs and budget. Plus allows you access to your other streaming services such as Amazon Prime and Netflix.

Already have Internet Service with Industry I-Net and experience with Streaming Services? Our service is App driven, so setup of your new TV service can be accomplished with just a phone call to our office and download of our App for service activation.



iVision Packages

- **iVision Local Plus**
 - 15 Channels - All HD: \$44.95
- **iVision Basic**
 - 80 Channels - All HD: \$99.95
- **Entertainment Package - Starz/ Encore Movie Pack**
 - 11 Channels- \$12.95

iVision Installation

\$99 Installation includes 2 Basic STBs with Wireless capabilities. Additional TVs will require additional charges.

\$25 Installation Applies when you self-install, and BYOD (Bring Your Own Device)

Additional Charges



iVision Video Streaming - Pricing Sheet

Recurring Charges

Local Plus Package	\$ 44.95	15 Channels, Locals, RFD, Outdoor and Fox News (3) Concurrent Streams, Restart TV, Catchup TV, SVOD - Video on Demand
Basic Package	\$ 99.95	80 Channels, Locals and Premium Channels (3) Concurrent Streams, Restart TV, Catchup TV, SVOD - Video on Demand
DVR Service (50 Hours)	\$ 4.95	50 hours of Cloud Based Storage, Record Multiple Streams Simultaneously
DVR Service Addl (50 Hours)	\$ 2.95	Additional 50 hours of DVR Cloud Storage
Additional Stream	\$ 1.50	Additional Concurrent Stream Customer Receives 3 Concurrent Streams with Service
Music Channels	\$ 1.50	50 Music Channels with a Variety of Venues
StarZ Package	\$ 12.95	16 Premium Movie Channels
HBOMax	\$ 25.00	15 Premium Movie Channels
Showtime	\$ 10.99	11 Premium Movie Channels
STB Maintenance	\$ 5.95	Monthly I-NET STB Maintenance Fee (Amigo7x)

Non-Recurring Charges

Install New Customer	\$ 99.95	Legacy \ Classic Installation with (2) Amigo7x STB's
Activation Fee	\$ 25.00	Customer Owned Equipment (Firestick, Android, Apple)
Install New Customer	\$ 25.00	All-In Package
Additional Amigo7x STB	\$ 59.95	Legacy \ Classic STB with Remote
Firestick	\$ 29.95	Video Materials
Tivo4k	\$ 29.00	Video Materials
HDMI Cable	\$ 5.95	Video Materials
Amigo7x Remote	\$ 14.95	Video Materials
Labor (per Hour)	\$ 65.00	Onsite Repair \ Customer Assistance

Setting up Your Amazon Firestick

Instructions below are for Firestick Gen 3 and newer, other versions of the Firestick may vary but should be generally close to the steps outlined in this document.

****Helpful Tip 1:** You will need an Amazon account to install the Firestick. If you don't have an Amazon account, please create an account by going to www.amazon.com. If you have an Amazon account already you are not required to create another account.

****Helpful Tip 2:** It would be good to have a computer, laptop, or phone with Internet access during the installation of the Firestick. During your installation you will need to go to www.amazon.com/code to enter your Firestick Device Code that will be presented during the installation. To enter the device code, you will be required to enter your Amazon Username and Password to enter the activation code for activation of your Firestick.

OK LET'S GET STARTED!!

1. Plug in the Firestick to open HDMI Port on TV, power up and use the remote from your TV to select the correct HDMI input. You will see the FireTV screen displayed if you are on the correct HDMI input port.
 - a. It will prompt you to press the >|| (Play/Pause) button on the Firestick remote to start the setup.
2. Choose your language by hitting the middle button in the control circle on the remote. (this is basically the enter key on the remote)
3. Connect to your Wi-Fi Network using your credentials to login into your home Wi-Fi provided by Industry I-Net.
4. Once connected to the Wi-Fi the Firestick will download the latest firmware and software updates. Once downloaded, Firestick Software will be installed and be sure not to power down while installation is in progress. (This entire process could take a while)
5. Once software updates are installed you will see a screen where you will need to enter your Amazon sign in information. If you don't have an Amazon account, you will need to create one by creating one at amazon.com as suggested earlier. Best to have PC access available to create account and enter registration information later in the installation process.
6. With your Amazon account credentials in place you can now proceed to sign into Amazon by using the middle button (ENTER) in the control circle to access sign-in procedures.
 - a. You will need to have a PC or Phone with Internet access available for the next step.
7. You will now see a screen showing the steps to complete activation of the Firestick. Sign into your Amazon account, once you are signed in go to amazon.com/code and here you to enter your activation code shown on your TV screen. This will register device and your TV screen will display a welcome from Amazon.
8. Follow the setup screens presented with your choice of preferences
9. You will then a screen preparing your Firestick Remote for pairing to your TV. Follow the on-screen instructions for pairing your remote to your TV.
10. Once you see that your Firestick Remote is paired successfully, select OK.
 - a. A lot of Amazon offerings will be presented, these offerings you can skip or select at your own discretion.

- b. A screen will appear that requests you to select your Streaming Services, please enter No Thanks at this time. You can always set these up again later. An introduction screen will appear displaying the functions available to you on the Firestick.
11. Your Account Name should appear on the Who is Watching Screen, select your user identity.
12. Navigate to the Find button on your screen and then navigate to Search, select the Search box and then when prompted with keyboard you can enter “industry ivision” and then enter. You will see our
 IVISION APP ICON, which is the APP you will need for Industry iVison Services. Select download and download will begin.
13. The Industry I-Net iVison App will install and will now be on your Firestick. You will select this APP when using our service. Open this device and enter the User ID and Password we provided you for your new TV service. You should see your identity which you can select, and you are in the iVison APP. You now have access to all the services you have requested for your account.
14. The APP is now installed on your Firestick and will be displayed in available APPs for you to select when you want to access to iVison services.
 - a. Once you get used to the functionality of the remote and screen Icons, you can move APP Icons around and customize the look of your user interface for the Firestick Home Page. You can select ICONS and move them around and we suggest that you move the iVison APP to the front of your available APPs for quicker access.

FireStick Generation 3 Remote Key Guide

Technical details



Alexa Voice Remote (3rd Gen)

Force Stop Your iVision App

1. Press the **Home** button on the remote to get to the Home screen.
2. Select **Settings** .
3. Choose **Applications**.

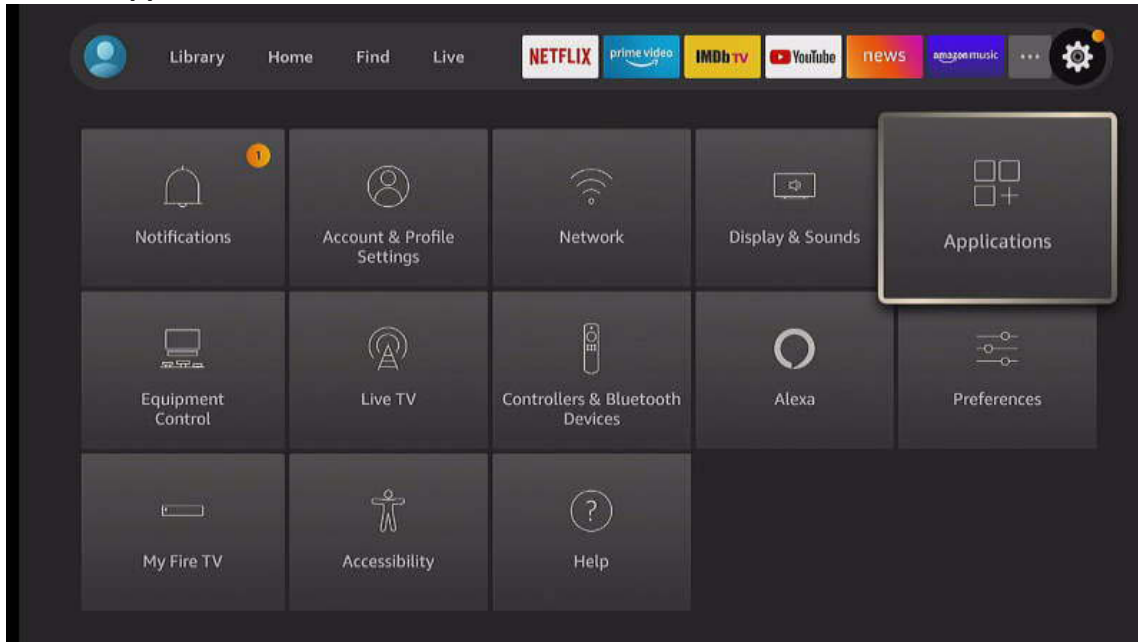

4. Select **Manage Installed Applications**.

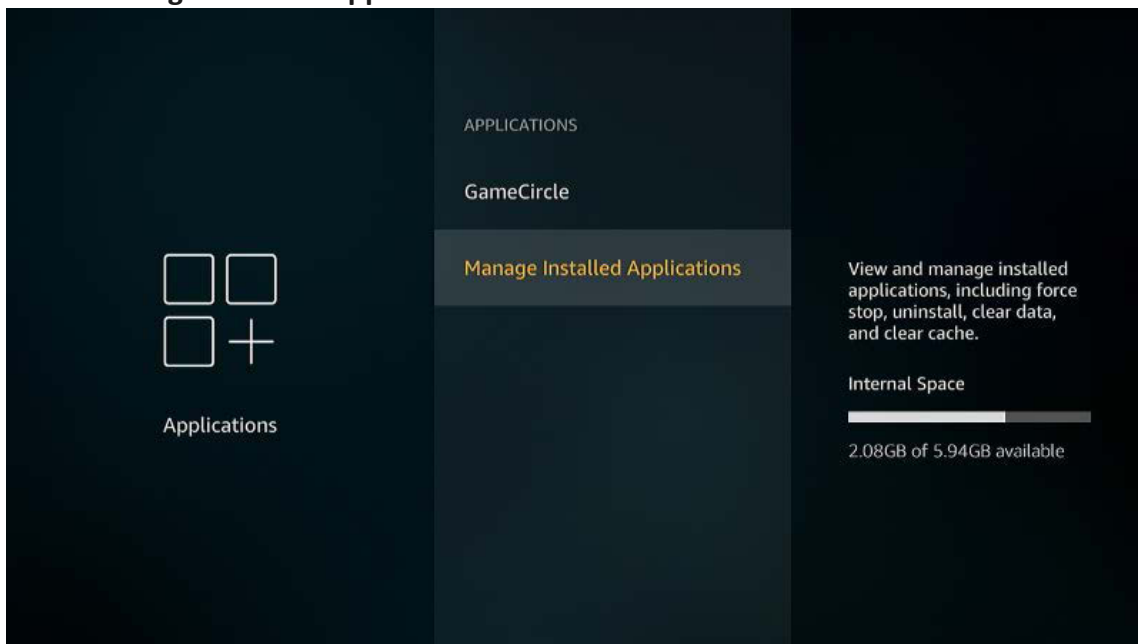

5. Choose the app you wish to close. In this example, we are choosing iVision. Click 'select' on iVision App.

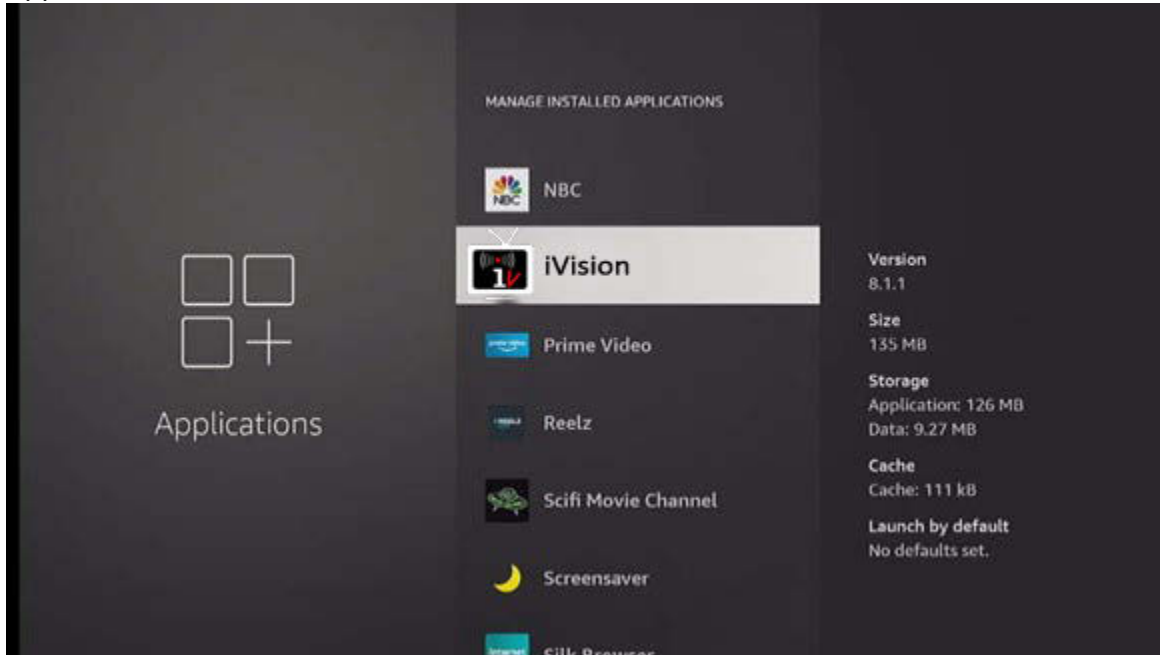

6. Select **Force stop**. The app will be closed. No message will appear on the screen to confirm this, which can make this process confusing. Once you have selected **Force stop**, you'll just have to trust that the app is closed.

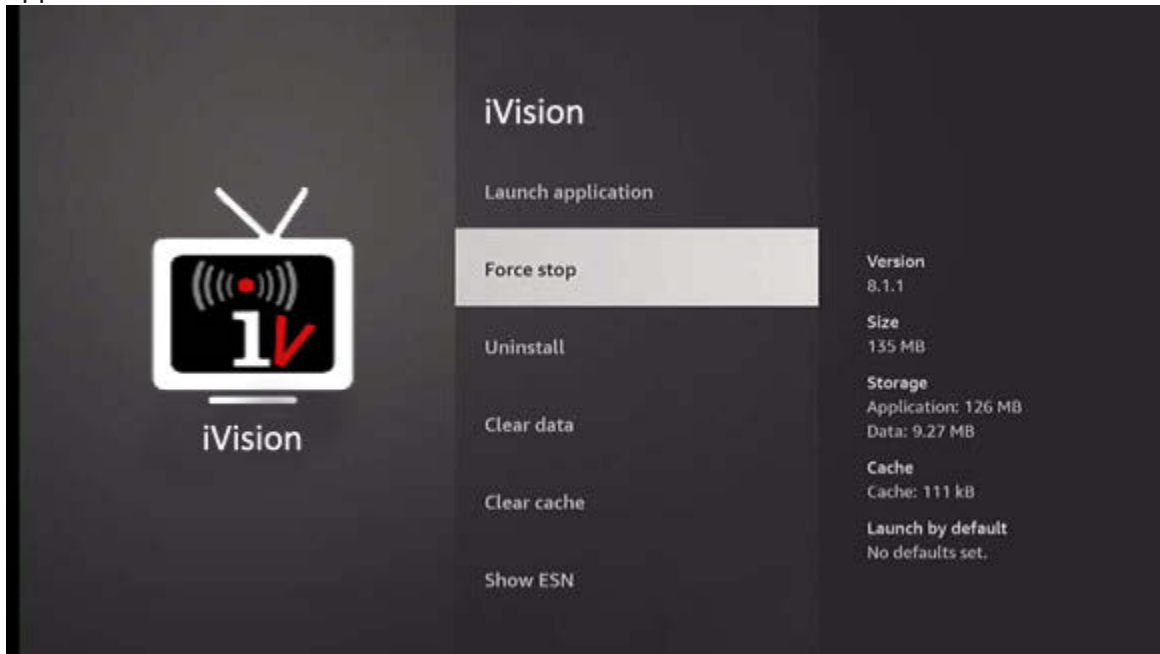

You are finished – and you can select the home button on your remote to go back to the Apps screen and re-open iVision.

Setting up Your TiVo Stream 4k

The instructions provided below are for the TiVo Stream 4k Android TV setup may vary in some instances but should be generally close to the steps outlined in this document. If you need additional help or more detailed information on the functions of the TiVo Stream 4k, it can be obtained online at the TiVo Website. The TiVo Stream 4k offers a lot of functionality that is not presented in this document which focuses only on setting of your TiVo Stream 4k to obtain our iVision TV service.

****Helpful Tip1:** You will need a Google email address to install the TiVo Stream 4k. If you don't have a Google email account, please create an account by going to Google to setup an email address. If you have a Google email account already you are not required to create another account. If you are unclear if you currently have a Google email address here is an example: (username@gmail.com)

****Helpful Tip2:** It would be good to have a computer, laptop or phone with Internet access during the installation of the TiVo Stream 4k for registration of your TiVo Stream 4k device.

****Helpful Tip3:** You can create a TiVo account in advance by visiting www.tivo.com/myaccount which will assist with in the installation because you will be required to enter your new TiVo's Device Code that is presented during the installation. If you wish to wait till later in the installation to create your account when the device code is presented, you will be directed to the link below to activate your device www.tivo.com/activate/stream4k.

OK LET'S GET STARTED!!

1. Plug the TiVo Stream 4K into your television's HDMI port.
2. Attach the USB power cord to TiVo Stream 4K and plug it into a power outlet using the supplied adapter. (Do not plug directly into a USB port or use a different USB adapter other than the one that was supplied.)
3. Power on your TV. (If you don't see Android TV welcome animation, you may need to switch inputs on your TV (using your TV remote) to select the correct HDMI port.
4. Once connected, follow the on-screen guide through the steps to get you enjoying your favorite entertainment quickly and easily with the TiVo Stream 4k.
5. Follow the on-screen instructions to pair your TiVo remote by pressing the TIVO button and the BACK button simultaneously until the activity light turns red. These buttons should be displayed on your TV screen.
6. After choosing your preferred language, skip the next step to quickly setup your TV with your Android phone. Select skip at this point.
7. Now you will connect to your WiFi network. (Note: It is possible that your TiVo Stream 4K might download and install an update at this time after you have connected to your Wi-Fi and internet connection is established). The updates may be quite large and take some time to download so please be patient. You will see a progress bar across the bottom of your TV screen showing the progress of the firmware download.

8. You now have an Option to sign into your Google Account and install additional apps and grab a quick overview of your Android TV capabilities, including the Google Play store, Google Assistant and Chromecast built in. This option can be skipped at this point, as you will be instructed below how to install APPs as you will required to install the Industry iVision APP for your TV service.
9. Now you will be asked to share your location, which is your option to select or skip.
10. Next a screen will be displayed to send diagnostic information to Google regarding your device, which is your option to select or skip.
11. The TiVo screen will now appear to walk you through the features of your TiVo device. Go through the screens one by one to see all the features available.
12. Once the step above has been completed, your TV will now display a six-character alphanumeric code which will have to be entered on the TiVo website for activation of your device.
13. Sign into your account at www.tivo.com/myaccount and enter the six-character alphanumeric code displayed on your TV screen. If you don't already have a TiVo account, use www.tivo.com/activate/stream4k to create one for this new device. Once you have entered your device code on the TiVo website, and activation code is accepted, your TV screen will move forward to the next step of the installation for the customization of your setup and streaming services.
14. TiVo Setup will now ask you to choose at least seven show favorites for TiVo to make future recommendations. Feel free, however, to opt out of the personalization questions at any time. We suggest you skip these one-by-one, but that is your preference. Once you have finished the personalizing steps select Finished Personalizing.
15. You will now be presented with a screen Add Streaming Originals to My Shows, just skip through the screens and select finished.
16. Next you will be present with default streaming services that are available to you. Such as Prime, YouTube, Netflix and etc....select the ones you want and a check mark will be shown in each service APP. If you are user of some of the Streaming services listed, please may sure you select them, so they are available to you when needed and Un-Select the ones you do not want. Select Finished when done.
17. At this point your TV is setup for Streaming services and installation is completed for the TiVo Stream 4k.

The Next Step allows you to setup communications to your audio receiver, where you can control your audio receiver with your remote....this is optional. Please refer to the TiVo website if you wish to use this option. If you select SKIP, you will now see all your available streaming APP's.

[back](#)

NOW IT'S TIME TO DOWNLOAD AND INSTALL THE INDUSTRY I-NET iVision APP, WHICH IS A FREE APP



18. On your TV you will see a Red Button on the Left of your Home Screen labeled Apps,  select this button and then select GET MORE APPS. At this point you will be required to sign into your Google email account to shop the Google PlayStore for our App. Follow the instructions presented on the screen.

19. Once you are logged into the Google PlayStore, at the very top of the screen will be a search button, select this icon to begin your search. To search for our APP please type in industry inet ivison in the



search box. Most likely you will see our icon  show up with as you are entering characters.

20. Use your remote to navigate to our APP and select install. Download and installation of Industry I-Net iVision will begin. Once completed you can open our APP.

21. You will now be prompted to enter your User ID and Password for our services which we have provided you. Example: User IND9842 Password 9842

22. Once you have Authenticated your iVision service it will be stored in your available APP listings under



to watch your selected video plan.

You can customize this ICON to be your default, so you don't have to select it each time when the TV is turned on by setting the APP to launch on boot. This can be found in the settings of the iVison APP, which is located at the top of your TV screen. Navigate to settings and moved the toggle switch to Set at Default APP. You can now exit the settings screen and the iVision APP will load automatically when you turn on your TV.

MORE INFORMATION ON YOUR TiVo STREAM 4K REMOTE

- 1 **POWER** turns television on or off.
- 2 **VOL** and **MUTE** control the TV audio.
- 3 When using the TiVo Stream app, the **TiVo button** opens the menu (Guide, My Shows, and more). From the Android TV home screen or any other app, the TiVo button opens the TiVo Stream app.
- 4 While navigating the TiVo menus, **UP**, **DOWN**, **LEFT**, or **RIGHT** move around. While watching video, **LEFT** and **RIGHT** are used for playback control (pause, fast-forward, rewind). Availability of playback control depends on the show and streaming service.
- 5 **OK/SELECT** chooses items on screen. A long press on a show title brings up an option menu. While watching video, **OK/SELECT** pauses/unpauses video.
- 6 **BACK** goes back to the previous screen. If no previous screen is available, **BACK** opens/closes the TiVo menu. In some streaming services, **BACK** returns to the TiVo Home screen.
- 7 The **circle button** opens the Android TV home screen.

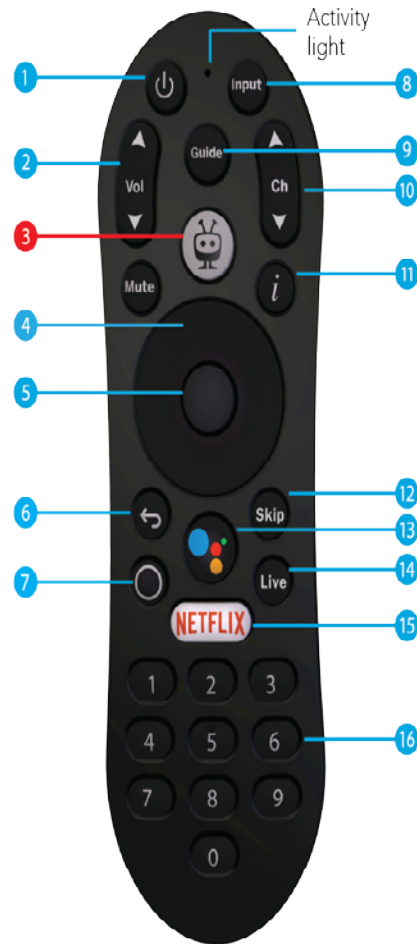



- 8 **INPUT** changes your video source (TiVo Stream 4K, gaming system, etc).
- 9 **GUIDE** takes you to the program guide.
- 10 **CHANNEL UP/DOWN** change the channel while watching live TV, and lets you scroll through the program guide quickly.
- 11 **"i" (Info)** displays show information when watching TiVo+. A long press opens the Accessibility settings screen (does not apply when watching video).
- 12 **SKIP** jumps forward 30 seconds while watching video. Availability depends on the show and streaming app.
- 13 Press and release the **Google Assistant button** to talk to Google.
- 14 **LIVE** jumps to the last watched channel from any TiVo Stream app screen, the Android TV home screen, and other apps on your device.
- 15 **NETFLIX** launches the Netflix app.
- 16 **NUMBER BUTTONS** can be used to quickly enter numbers (for instance, when entering a password).

Remote Pairing

To use TiVo Stream 4K, your remote must be paired with the device. You'll be prompted to do this during device setup, and if your remote can control your TiVo Stream 4K, then the remote is paired correctly. However, if you get a new remote or if your remote ever becomes unpaired, you may need to pair it manually. There are two options for doing so.

Manual Pairing Option 1

Press and release the TiVo button. The activity light will flash amber while the remote is pairing.

NOTE: To pair a remote that has been used before, press and hold the TIVO  and BACK  buttons simultaneously until the activity light turns red. Release the buttons, and the remote will begin pairing.



Manual Pairing Option 2

If you are unable to use the remote to reach the Settings screen, press the button on the side of your TiVo Stream 4K for 3 seconds to display the pairing screen. Then follow the on-screen instructions.

Press button
for 3 seconds.



Alternatively, you can pair a new remote from the Android TV settings menu. Press the circle button on the remote to go to the Android TV home screen, then choose the gear icon to go to the Android TV settings menu. Select “Remotes & Accessories” to pair your remote.

Remote Setup

The TiVo Stream 4K remote can be set up to control your TV, sound bar, or A/V receiver's volume, mute, and input functions.

1. Press the circle button on the remote to go to the Android TV home screen, then choose the gear icon to go to the Android TV settings menu.

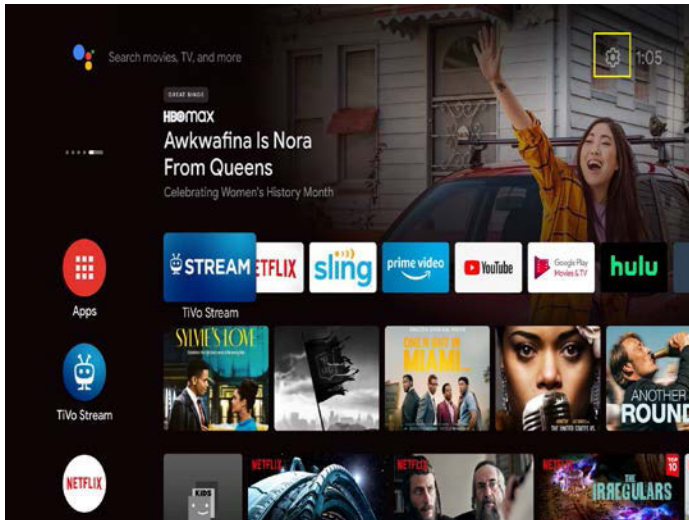

2. Choose *Remote & Accessories* > *TiVo Remote*.

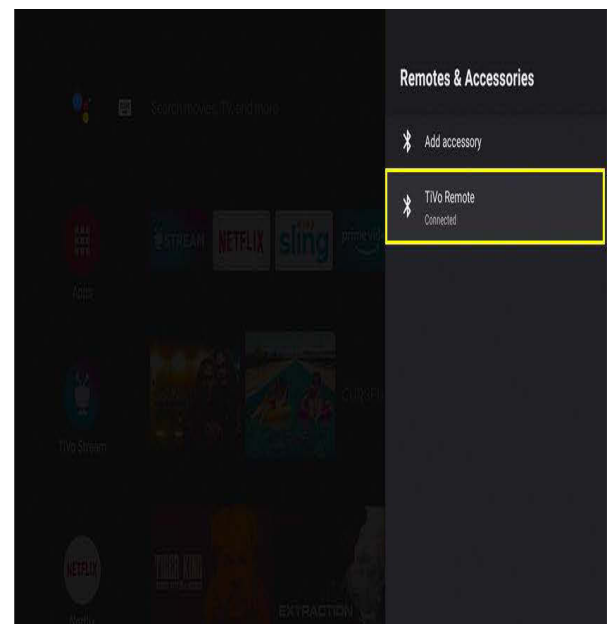
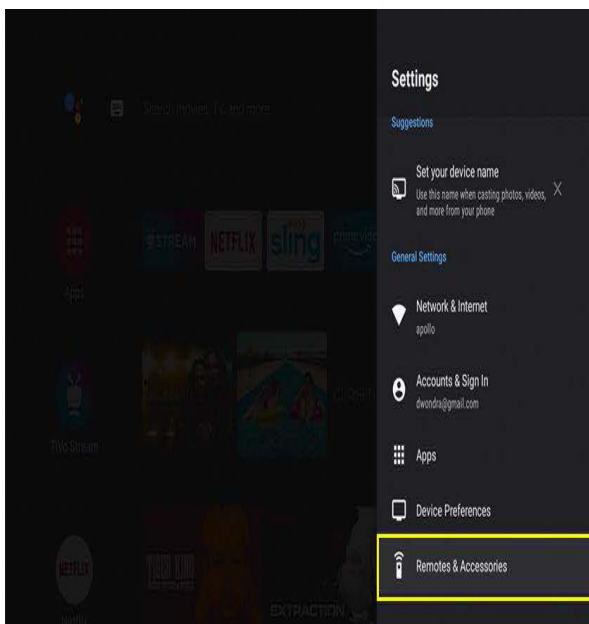

3. Choose one of the options on this screen:

- Change TV Setup: Use this option to control your TV's power, input, and volume.
- Change Audio Setup: Use this option to control an external audio device (e.g., a sound bar or A/V receiver).
- Change Volume Control: Use this option to switch between controlling the volume on your TV or receiver.

audio device (sound bar or A/V receiver). This function can be useful for using ARC with an Audio device.

For additional help setting up your remote, visit [TiVo Support](#).

Remote Troubleshooting

If your remote cannot be paired with your TiVo Stream 4K, you may need to perform a factory reset of the remote. This reset will unpair your remote from your TiVo Stream 4K and all other devices it is paired with.

1. Press and hold the TiVo and TV POWER buttons on the remote simultaneously for approximately 3 seconds.
2. The activity indicator will be lit red and will stay on.
3. Press VOLUME DOWN 3 times, and then press the TiVo button.
4. The activity indicator will flash red 3 times.
5. Pair your remote by following the instructions in the "Remote Pairing" section above.

Traditional Amino Amigo Set Top Box with Maxi Remote

Amino Maxi Remote



Maxi ATB Remote Control User Guide



Remote control layout

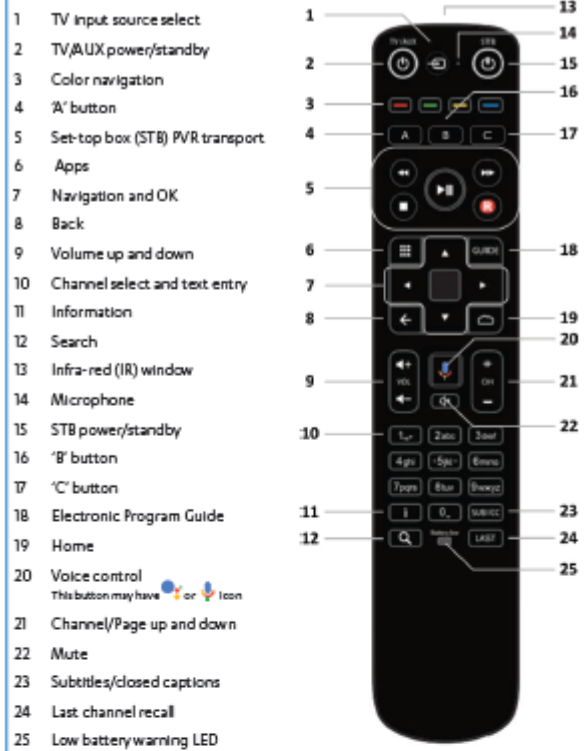

Note: Some functionality (e.g. PVR) may not be available on specific models of set-top box (STB), also functionality may vary with the TV service delivered by your service provider.

1. Activate batteries

To activate batteries, pull out the plastic tab

2. Controlling the STB (pairing the remote control)

The Maxi remote control is designed to control your STB and (optionally) your TV or auxiliary device.

During the initial setup of the STB, you will be guided through the process of pairing the remote control with the STB. The figure below is what you can expect to see on your TV screen.



- 1) Point the remote control at the STB. Do not cover the Infrared (IR) window on the front of the remote control and at the front of the STB.
- 2) Press and hold the OK and PPS buttons simultaneously for 5 seconds or until the STB button blinks twice.
- 3) Release the buttons.
- 4) The STB button should be illuminated blue.

Once the pairing is successful, you will see a short blink and pairing screen will disappear.

Note: The remote is in "pairing mode" when the STB button is illuminated blue. During pairing mode, no remote control keys will work except the BACK key. You must press BACK to stop pairing or to use another function.

3. Controlling the TV

The Maxi remote control for Android TV supports a "Simple Remote Wizard" to automatically detect the TV brand connected to your STB via HDMI. The Wizard will guide you through the steps to confirm that the remote control is able to control your TV. The image below is the first screen of the Simple Remote Wizard.



If you receive a new remote control, you can trigger the Simple Remote Wizard by going to: Settings>Device Preferences>Remotes and Accessories. Select your remote control from the list and choose "Simple Setup".

Battery Information

Do not mix different types of battery or old and new batteries.

Do not use rechargeable batteries.

Remove the batteries from the remote control if you are not going to use it for several weeks, to avoid the risk of leakage.

Please respect your environment and any local regulations and dispose of old batteries in a responsible manner.

Do not attempt to recharge the batteries.

Immediately remove any leaking batteries.

Take care when handling leaking batteries as they may cause burns to the skin or eyes, or other physical injuries.

What if my TV/Aux device cannot be found? (IR Learning)

The Maxi ATV remote control can learn a key function from another 'source' remote control.

1. Choose your 'target key' on the remote control. It must be one of the following keys: TV/ALIX POWER / TV INPUT / VOL+ / VOL- / MUTE. This key will learn a function from the source remote control.
2. Press 4 and 6 for at least three seconds. The TV/ALIX POWER key will flash twice and remain on.
3. Press your target key within 30 seconds:
 - If valid, the TV/ALIX POWER key will give a confirmation flash and remain on.
 - If invalid, or you do not press within 30 seconds, the TV/ALIX POWER key will give a long flash and return to user mode.
4. Hold the Maxi ATV remote control 3-6 cm from the source remote control with the IR windows facing each other, then press your target key on the source remote control (e.g. If your target key on the Maxi ATV remote control is mute, press mute on the source remote control).
5. If the IR signal is received correctly, the TV/ALIX POWER key will turn off and the remote control will return to normal mode (note: this can overwrite a previously learned code).
6. If the IR signal is not received correctly, or is received after 30 seconds, the Maxi ATV remote control will not store the code from the source remote control: it will give a long flash and return to user mode.
7. If the Back key is pressed on the remote control while it is waiting for an IR signal, the TV/ALIX POWER key will give a long flash and return to user mode. (If the target key is pressed, any learned code on it is cleared.)
8. To clear the target key, press 4 and 6 for at least three seconds. The TV/ALIX POWER key will flash twice and remain on. Then press your target key twice. The TV/ALIX POWER key will flash to confirm the target key is cleared.

How do I return my remote to Factory Settings?

1. Press 1 and 6 for at least three seconds until the TV/ALIX POWER key flashes twice then stays on.
2. Enter the key sequence 9 8 1. After completing the sequence the STB key will flash twice. The TV settings are now deleted from the remote control and it returns to factory settings: Bluetooth mode, and unpaired.

Troubleshooting iVision TV Service

Common iVision Issues & Solutions

- **No picture showing when connected to TV.**
 - Check HDMI cable is connected properly between the STB & the TV.
 - Verify that the TV is selected to the proper input.
 - Check STB to make sure the power light is on.
 - Use remote to attempt channeling up/ down.
 - Complete a system reboot.
- **Choppy picture that freezes occasionally.**
 - Select another channel(s) to see if the other channels are choppy too.
 - Complete a system reboot.

Completing a System Reboot

- What is a system reboot?
 - Unplug the power to the set top box and the modem. In some cases, depending on specific setup, switching a power strip to off and then back on may be all that is required. Once the system comes back up, make sure all TVs and channels are working, and then turn off each TV.
- When should a customer do a reboot?
 - Reboot the system when all other methods of resolving the issue have failed.
 - Reboot the system after the customer has upgraded channel packages or other minor changes to system. The reboot will need to be done after the new services are provisioned or as directed by Industry I-Net.

When a System Reboot Does Not Resolve a Problem

If you experience problems with any of your services and a system reboot does not resolve your trouble, please contact Industry I-Net immediately to report. It is very important when reporting trouble with your IPTV service that you provide as much information as possible about the issue you are experiencing and please provide the CHANNEL or CHANNEL NUMBERS that you are having problems with.

These issues need to be reported to INDUSTRY I-NET as soon as possible:

- Picture Tiling ('little boxes', digitizing, pixilation)
- Picture Freezing
- Audio Freezing
- Channel Freezing
- Video Stream Freezing
- Poor Picture Quality (snowy, grainy, fuzzy, or blurry)
- IPTV Set Top Box must be rebooted too often
- Can't Change channels – often this issue can be resolved by pressing the STB button on the remote. This should re-sync the remote to the set top box. If this does not resolve the issue please contact Industry I-Net.

Industry I-Net is committed to providing you with the best TV experience. Please call us anytime you experience any problems with any of your services.

How do I record a program and how do I access them?

- Recording a program can be done in the Live TV Guide.
 - A scheduled program recording will have a circled dot icon next to the name in the Live TV Guide.

Record a Future Program

- Find the program you would like to record in the guide. (Past programs cannot be recorded.)
- Press the Select button once to see the program detail and again for record options.
- Navigate to the Record options and Select. The recording menu will appear. Here, you can record the current episode or the series, if available.
 - To record the current episode, select Record Episode. That's it!
 - To record the program series, select Record Series. The series will record, but you can also change these three options: channel to record, record new or all episodes, and choose how many episodes to keep.

Record a Current Program

- While watching the program, the recording will start from where you are in the program. To start recording from the beginning, you must Restart. (See Restart instructions).
- To record press the Select button and Navigate to the record icon (circled dot) and click Select. Stop the recording by doing those steps again.

Manage Your Recordings

- To watch or change your recordings, follow these steps:
 - Go to the Menu and Select Recordings.
 - Navigate to the program (or series) to view and Select.

How to Setup TV Everywhere

1. Visit wtve.net
2. Select the “Register” link.
3. Create a login using your Industry I-Net TV account number.
 - a. If you cannot find this account number, please call our office to get this information.
 - b. You only need to enter the last name on the account
4. The email address you use to set up the account will be your username.
5. Once you click submit, you will get an email to complete the registration.
6. Once you have created a login, there are two ways to watch tv-
 - a. You can go to the Watch TV Everywhere website and login, you will see a list of networks to choose from.
 - b. You can download the individual apps for the networks on your smartphones and or tablets. You will login with the credentials you used to sign up with on the Watch TV Everywhere website.
7. Either way you choose, once you login you will be asked to select the service provider
8. Using the drop-down menu, scroll down and select Industry I-Net.
9. Then provide use your username/password, which you set up previously on the TV Everywhere website.